

PAPER • OPEN ACCESS

Retrofit against fatigue cracking at web penetration details with a slot in steel girder

To cite this article: Chihiro Sakamoto *et al* 2018 *IOP Conf. Ser.: Mater. Sci. Eng.* **419** 012008

View the [article online](#) for updates and enhancements.



IOP | ebooks™

Bringing you innovative digital publishing with leading voices to create your essential collection of books in STEM research.

Start exploring the collection - download the first chapter of every title for free.

Retrofit against fatigue cracking at web penetration details with a slot in steel girder

Chihiro Sakamoto¹, Masahiro Sakano², Hideyuki Konishi³ and Takashi Fujii⁴

¹Japan civil engineering consultants association, Osaka, Japan

²Kansai University, Suita, Osaka, Japan

³Japan Bridge Association, Osaka, Japan

⁴Ministry of Land, Infrastructure and Transport, Himeji, Japan

E-mail: sakamoto_ssd@yahoo.co.jp

Abstract. Fatigue cracking in steel girder web penetration details is so dangerous that it can break steel girders. The purpose of this study is to clarify fatigue behavior of web penetration details with cross beam flange welded to upper or lower surface of a slot by fillet welding, and verify the effect of retrofitting methods against fatigue cracking in web penetration details. As a result, fatigue cracks were initiated at the web-side toe of the fillet weld along cross beam lower flange edges both in upper and lower welded specimen. In the upper welded specimen, fatigue cracks were propagated into the web plate diagonally upward almost perpendicularly to the maximum principal stress direction. Whereas in the lower welded specimen, fatigue cracks were propagated into the web plate vertically downward faster than in the case of the upper welded specimen, and broke the lower flange. The fatigue life of the lower welded specimen was shorter than that of the upper welded specimen. As a preventive measure, weld toe grinding can extend fatigue life a little, but cannot prevent crack initiation perfectly. As a post cracking measure, a stop hole can stop crack propagation of long cracks, whereas crack removal and shaping up method by grinding can prevent crack propagation of short cracks.

1. Introduction

Fatigue cracking in steel girder web penetration details is so dangerous that it can break steel girders [1]. One-meter-long crack was detected in Yamazoe Bridge in 2006 [2]. Since a number of highway bridges with such web penetration details may exist in Japan, it is of urgent importance to grasp these fatigue strength properties. However, few fatigue tests have been reported on steel girder web penetration details [3], [4]. The previous study reported fatigue behavior of steel girder web penetration details in which cross beam flange was welded to upper surface of a slot by fillet welding [5]. Then, the purpose of this study is to clarify fatigue behavior of the web penetration details with cross beam flange welded to upper or lower surface of a slot by fillet welding, and verify the effect of retrofitting methods against fatigue cracking in web penetration details.

2. Experimental procedure

2.1. Specimen

We designed and fabricated two type steel girder specimens with web penetration details where a cross beam lower flange was connected to each upper or lower surface of a slot by fillet welding. Figure 1 shows configurations and dimensions of each specimens; upper welded specimens (U1, U2), lower welded specimens (L1, L2), and Figure 2 shows the location of strain gauges. The number of



specimens is two for each type. The specimen has a slot in the lower center of steel girder web. The material is JIS 490YA steel. Submerged arc welding was used to connect web and flanges, while CO₂ arc welding was used to connect the other members.

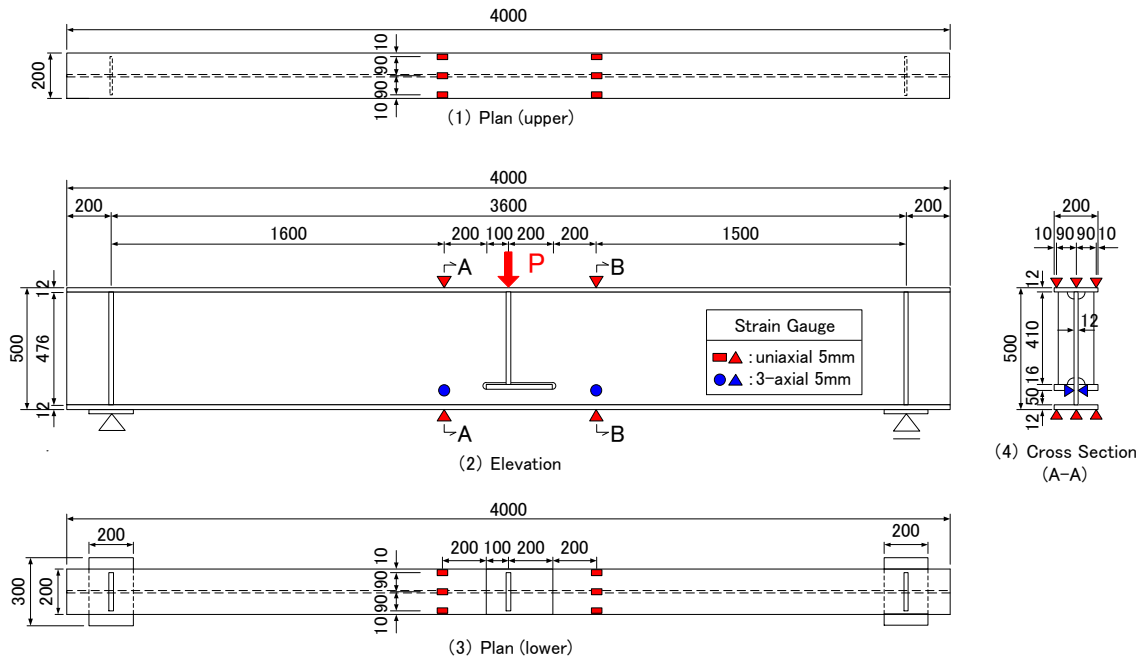

Figure 1. Configurations and dimensions of specimen

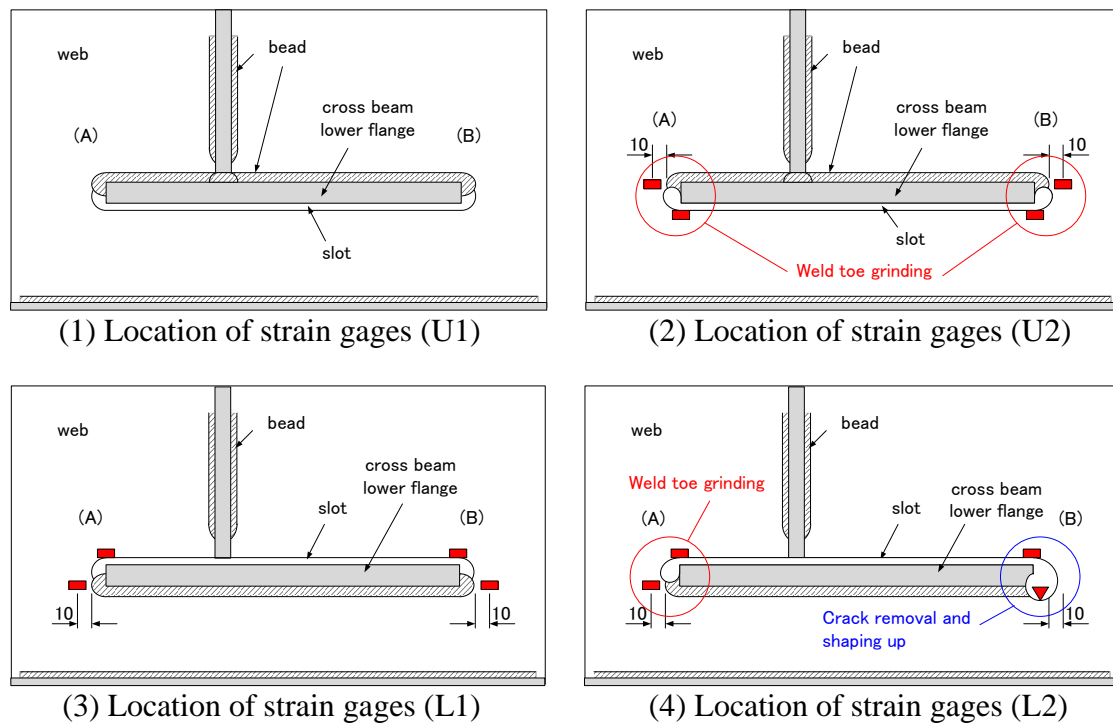

Figure 2. location of strain gauges

2.2. Retrofitting method

2.2.1. Preventive measures

(1) Weld toe grinding

Weld toes were ground using a bar grinder in the upper welded specimen U2 (A and B), and the lower welded specimen L2 (A). Photo 1 shows the condition of ground weld toe of U2 specimen (A).

(2) Crack removal and shaping up

Initial defects were removed and shaped up using a bar grinder in the lower welded specimen L2 (B). Photo 2 shows the condition after crack removal and shaping up of L2 specimen (B).

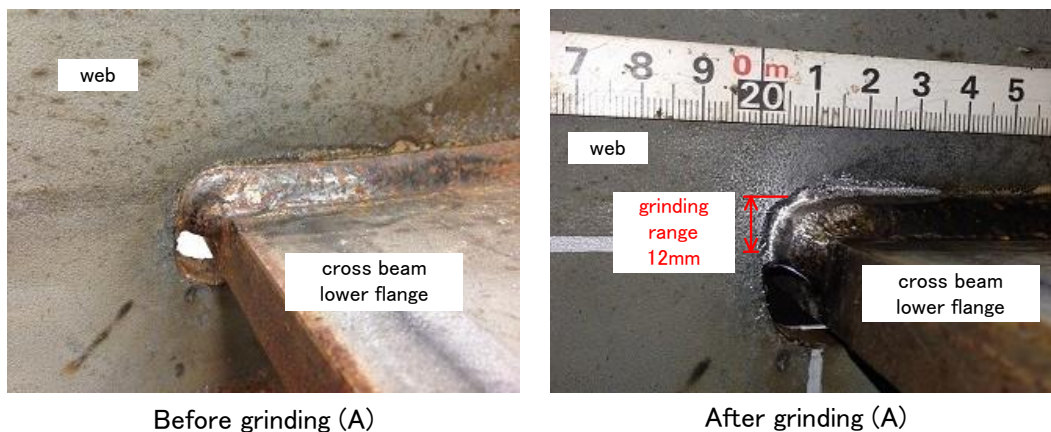

Before grinding (A) After grinding (A)
Photo 1. Condition of ground weld toe (U2 (A))

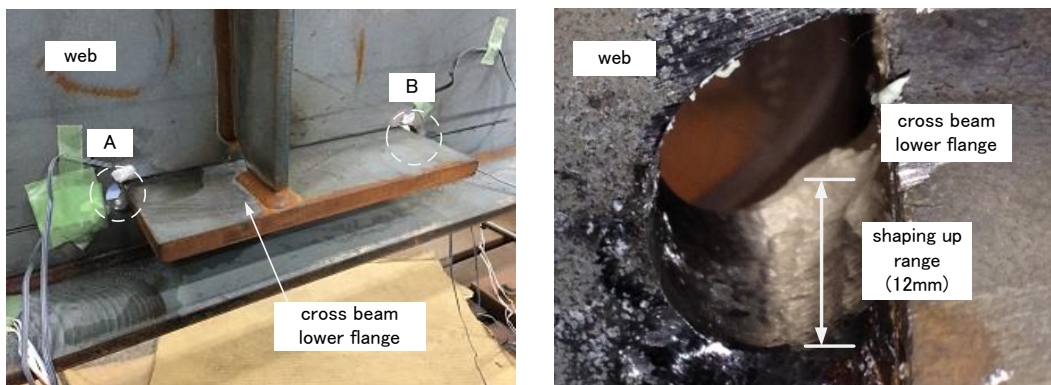

Photo 2. After crack removal and shaping up method (L2 (B))

2.2.2. Post cracking measure

(1) Stop hole and high tension bolt

A stop hole (SH) was drilled and a high tension bolt (HTB) was tightened at the crack tip of long cracks, in order to stop crack propagation in the upper welded specimen U1 (A).

(2) Crack removal and shaping up method

Short fatigue cracks were removed and shaped up using bar grinder, in order to prevent crack re-initiation in the lower welded specimen L1 (A).

2.3. Static loading test

First, we conducted static loading test in 3-point bending condition to grasp the stress distributions around web penetration details. 3-axis strain gauges were pasted on both surfaces of the web plate horizontally 100mm away from cross beam lower flange edges to avoid the influence of the stress

concentration near the welded joint. Three 1-axis strain gauges were pasted on the upper surface of upper flange and the lower surface of lower flange in the cross section where 3-axis strain gauges were pasted. The test load was set to 100kN so that the maximum tensile stress of about 50MPa might be generated in the lower flange considering the live-load stress.

2.4. Fatigue test

Table 1 gives fatigue test steps. Fatigue test was conducted in 3-point bending condition as static loading test to clarify fatigue cracking behavior and fatigue life. The loading frequency was 6Hz. The load range was set to be 100kN, with the maximum load of 300kN and the minimum load of 200kN, considering the dead-load stress. In the case of a fatigue crack was propagated in one of two tested area, a stop hole was drilled and a high strength bolt was tightened to continue fatigue tests. Magnetic Particle Test (MT) was applied to detect fatigue cracks at weld toe along cross beam lower flange edges.

Table 1. Fatigue test steps

		Preventive Measure	Post Cracking Measure
U1	A	as weld	SH, or SH and HTB
	B	as weld	-
U2	A	weld toe grinding	-
	B	weld toe grinding	-
L1	A	as weld	-
	B	as weld	-
L2	A	weld toe grinding	crack removal and shaping up
	B	crack removal and shaping up	-

3. Test results

3.1. Static loading test results

Figure 3 shows principal stress distributions around web penetration details. Nominal stresses were obtained from bending moment and shearing force calculated according to the beam theory neglecting the cross beam lower flange and stiffeners. It was confirmed that the measured maximum principal stresses nearly equal to the calculated values, although the measured value was about 2~6% larger than the calculated one.

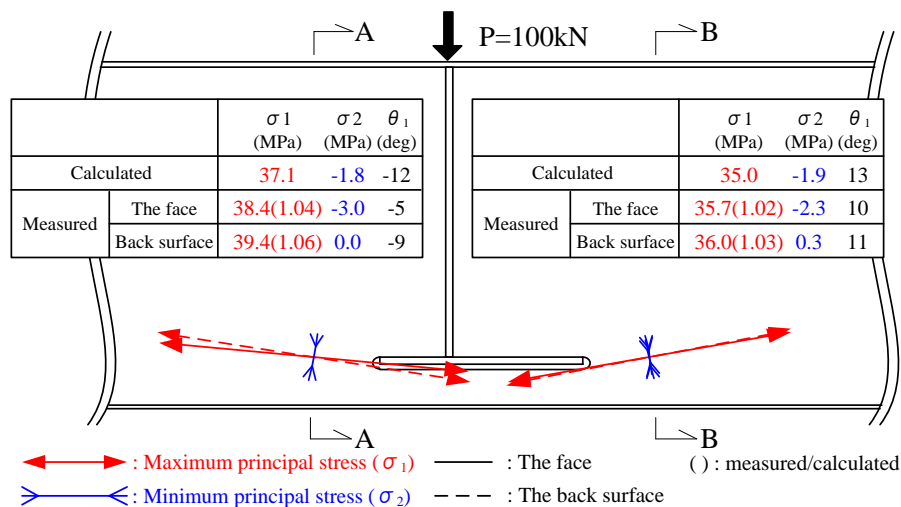

Figure 3. Principal stress distributions around web penetration details

3.2. Fatigue test results

3.2.1. Fatigue cracking behavior

(1) Fatigue crack initiation behavior

Figure 4 shows relationship between the fatigue crack length and the number of loading cycles for specimens U1 and L1. Fatigue cracks were initiated at the web-side toe of the fillet weld along cross beam lower flange edges.

(2) Fatigue crack propagation behavior

In the U1 specimen (A), fatigue cracks were propagated into the web plate diagonally upward almost perpendicularly to the maximum principal stress direction. In the L1 specimen (A), fatigue cracks were propagated into the web plate vertically downward faster than in the case of the upper welded specimen, and broke the lower flange. Because the bending stress increases as approaching the lower flange of the main girder.

Figure 5 shows relationship between the fatigue crack length and the number of loading cycles of specimens U2 and L1. In the U2 specimen, crack propagation rate ($\Delta a/\Delta N$) becomes smaller as approaching the neutral axis. Because the bending stress decreases as approaching the neutral axis.

(3) Fatigue life

Figure 6 shows the relationship between bending stress range and fatigue life of the specimens U1, U2, L1 and L2. In the U1 and L1 specimens (as weld), fatigue life when the crack was detected at web-side toes of the fillet welds along cross beam lower flange edges (N_d) is 1/5 of class H' (the lowest fatigue class in Japanese Specifications for Highway Bridges [6]), fatigue life when the crack was propagated into the web plate (N_w) was less than class H', and fatigue life when the crack length reaches 30mm (N_{30}) satisfies class H'.

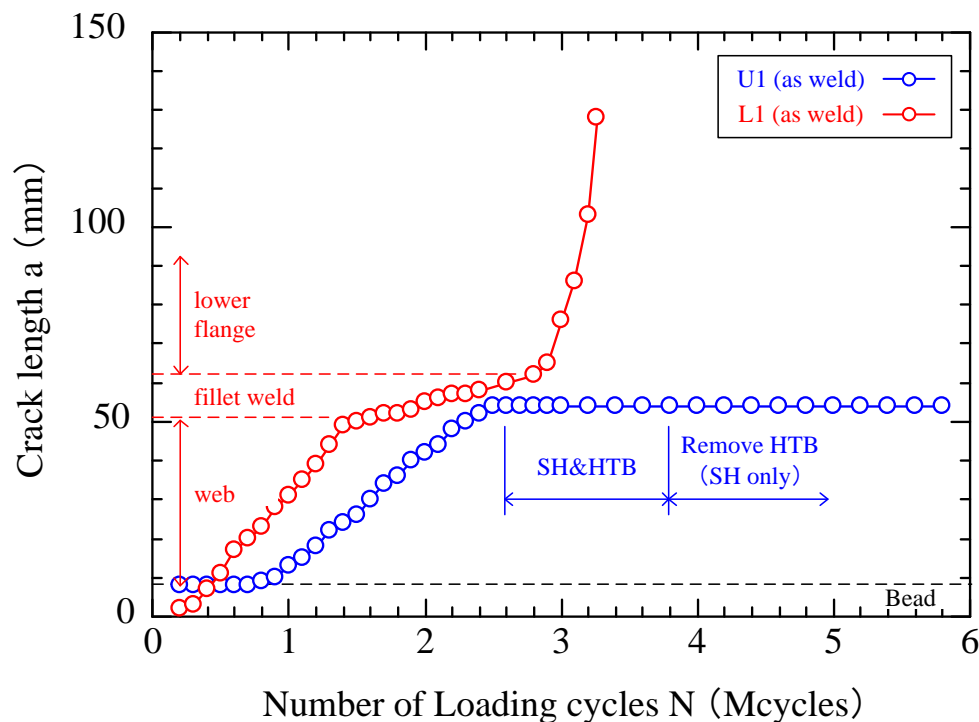

Figure 4. Relationship between the fatigue crack length and the number of loading cycles of U1 and L1

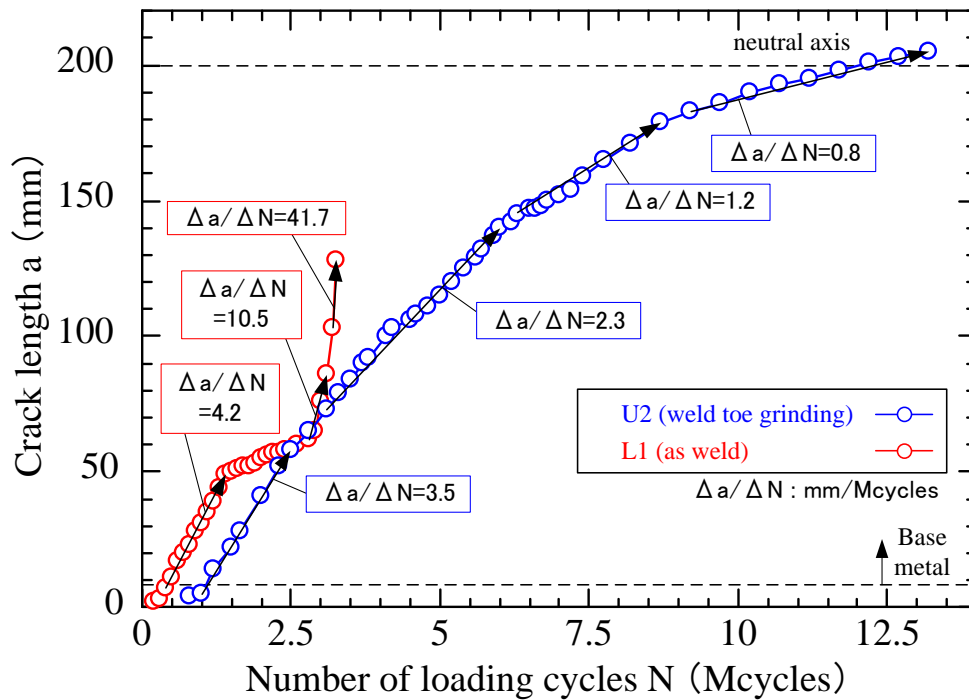

Figure 5. Relationship between the fatigue crack length and the number of loading cycles of U2 and L1

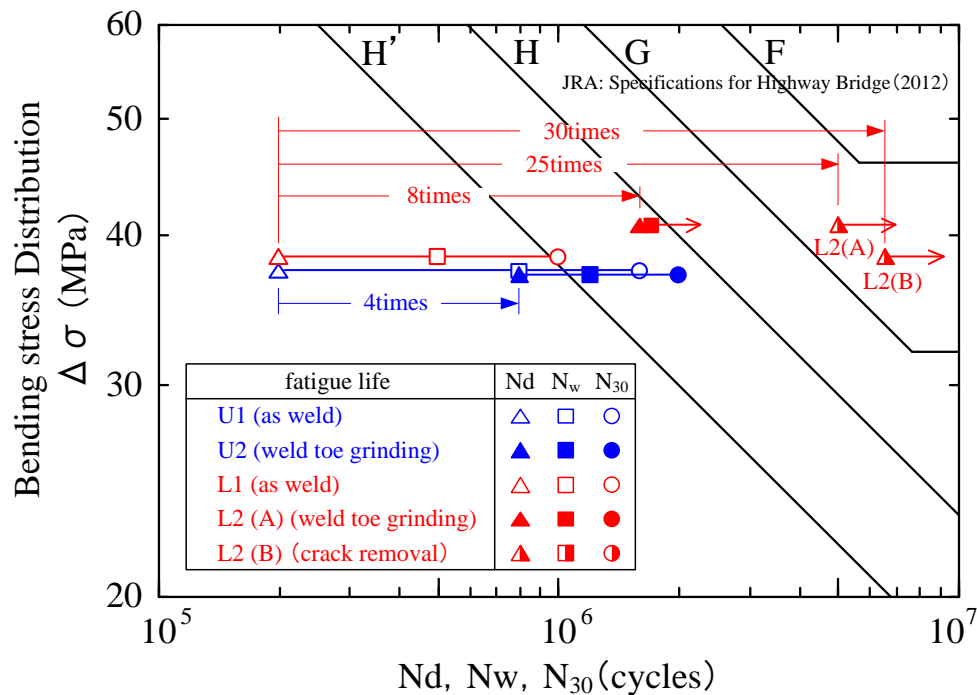

Figure 6. Fatigue life of specimens U1, U2, L1 and L2

3.2.2. Effectiveness of retrofitting method

(1) Preventive measure

a) Weld toe grinding

Crack initiation life of U2 specimen was four times of that of U1 specimen (as weld) as shown in Figure 6, but fatigue cracks were propagated, similarly as U1 specimen, into the web plate diagonally upward almost perpendicularly to the maximum principal stress direction.

Figure 7 shows relationship between the fatigue crack length and the number of loading cycles of specimens L1 and L2. Crack initiation life of L2 specimen (A) is eight times of that of L1 specimen (B), but fatigue cracks were propagated, similarly as L1 specimen, into the web plate vertically downward.

Therefore, this method can extend fatigue life a little, but cannot prevent fatigue crack initiation perfectly as shown Figure 6.

b) Crack removal and shaping up method

In the L2 specimen (B), no fatigue cracks were detected (see Figures 6 and 7). Therefore, crack removal and shaping up method can prevent fatigue crack initiation perfectly.

(2) Post cracking measure

a) Stop hole and high tension bolt, or stop hole only

In the U1 specimen (A), both of SH method and SH and HTB method can stop crack propagation of long cracks as shown in Figure 4.

b) Crack removal and shaping up method

In the L2 specimen (A), crack removal and shaping up method by grinding can stop crack propagation of short cracks as shown in Figures 6 and 7.

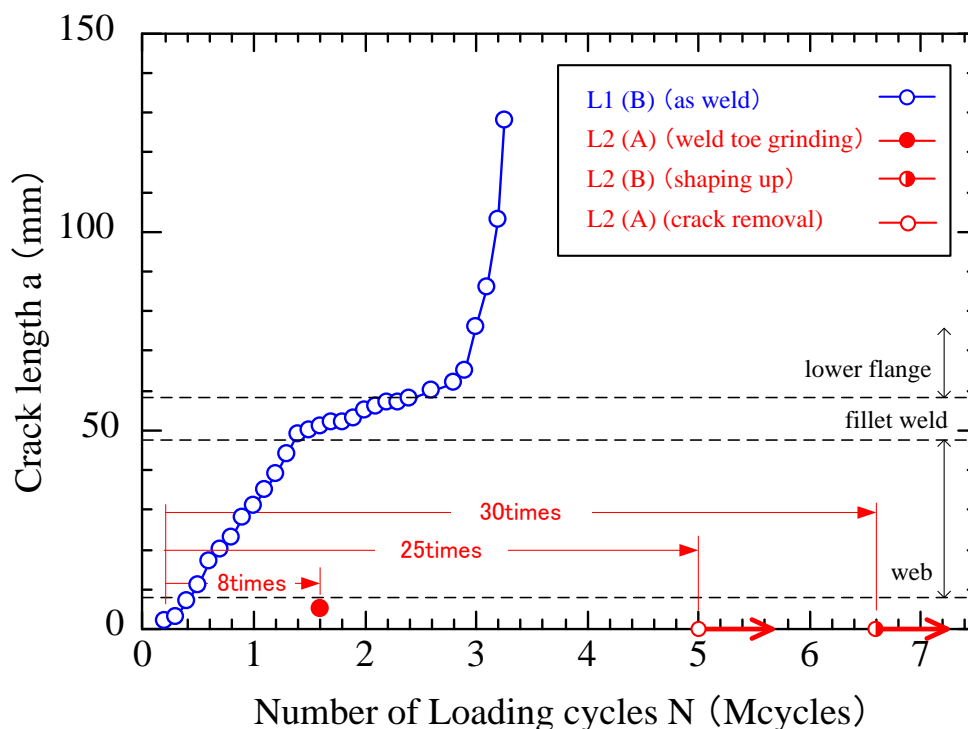

Figure 7. Relationship between the fatigue crack length and the number of loading cycles of L1 and L2

4. Conclusion

The principal results obtained through this study are as follows;

- (1) Fatigue cracks were initiated at the web-side toe of the fillet weld along cross beam lower flange edges both in upper and lower welded specimen.
- (2) In the upper welded specimen, fatigue cracks were propagated into the web plate diagonally upward almost perpendicularly to the maximum principal stress direction, whereas in the lower welded specimen, fatigue cracks were propagated into the web plate vertically downward faster than in the case of the upper welded specimen, and broke the lower flange.
- (3) The fatigue life of the lower welded specimen was shorter than that of the upper welded specimen.
- (4) As a preventive measure, weld toe grinding can extend fatigue life a little, but cannot prevent crack initiation perfectly.
- (5) As a post cracking measure, a stop hole can stop crack propagation of long cracks, whereas crack removal and shaping up method by grinding can prevent crack propagation of short cracks.

For existing bridges, stop hole and crack removal are recommended to stop crack propagation. For new bridges, web penetration details with a slot should not be used. Further researches are necessary on countermeasures to prevent fatigue crack initiation perfectly.

References

- [1] Fisher, J. W.: Fatigue and Fracture in Steel Bridges, Chapter 6, Wiley-Interscience, 1984.
- [2] Nara National Highway (<http://www.kkr.mlit.go.jp/nara/>). (in Japanese)
- [3] Sakano, M., Mikami, I., Murayama, H., Moriwaki, K.: Fatigue Strength of Railway Plate Girder with Web Penetration, Journal of Structural Engineering, Vol.41A, pp.965-973, 1995. (in Japanese)
- [4] Sakano, M., Hozumi, M., Shimora, T., Mikami, I.: Long Term Fatigue Strength of Web Gusset Joint in Floor-Beam-to-Main-Girder Connection, Steel Construction Engineering, Vol.5, No.18, pp.31-40, 1998. (in Japanese)
- [5] Yoshida, N., Sakano, M., Konishi, H., Fujii, T.: Fatigue Test of Steel Girder Web Penetration Details with a Slit, Sustainable Solutions in Structural Engineering and Construction, pp.95-100, ISEC Press, 2014.
- [6] Japan Road Association: Specifications for Highway Bridges, Part I (General) and II (Steel bridges), 2012. (in Japanese)